

edge[®]
blu



INSTRUCTION MANUAL

 HANNA[®]
instruments

**Dear
Customer,**

Thank you for choosing a Hanna Instruments product.

Please read this instruction manual carefully before using the instrument.

This manual will provide you with the necessary information for correct use of the instrument, as well as a precise idea of its versatility.

If you need additional technical information, do not hesitate to e-mail us at tech@hannainst.com or view our worldwide contact list at www.hannainst.com.

Hanna Instruments reserves the right to modify the design, construction or appearance of its products without advance notice.

Included.....	4
Safety Measures.....	4
Description.....	5
Diagram.....	5
Product Diagram.....	5
Probe Diagram.....	7
Guide to Indicators Probe.....	7
Keypad Function.....	8
Guide to Indicators Instrument.....	9
Setup/Installation.....	10
Setting Up edge[®] blu	10
Probe Connections.....	13
General Setup.....	14
pH Configurations.....	17
Basic Mode.....	17
Logging Function.....	17
Viewing Logged Data.....	20
PC & Storage Interface.....	22
Operational Guide.....	25
Basic vs Standard pH Mode.....	25
Connecting the HALO™ probe.....	26
pH Calibration.....	26
Calibration Messages.....	32
pH GLP Information.....	34
pH Measurement.....	36
Maintenance.....	39
pH Probe Maintenance.....	39
pH Probe Battery Replacement.....	41
Troubleshooting Guide.....	42
Specifications.....	43
edge[®] blu Specifications.....	43
HI11102 Specifications.....	44
Accessories.....	45

Remove the instrument from the packing material and examine it carefully to make sure that no damage has occurred during shipping. If there is any damage, please contact your local Hanna Instruments Office.

Packaging for **edge[®] blu (HI2202)** includes:

Bench cradle

Wall cradle

Electrode holder

USB cable

5 Vdc Power Adapter

Instruction Manual and Quick Reference Guide

Certificate

HI11102: HALO™ pH Probe with Bluetooth® Smart Technology

pH Calibration Solution kit

Note: Save all packing material until you are sure that the instrument works correctly. Any defective item must be returned in its original packing.

Before using this product, make sure that it is entirely suitable for your specific application and for the environment in which it is used.

Operation of this instrument may cause interference to other electronic equipment, requiring the operator to take steps to correct interference. Any variation introduced by the user to the supplied equipment may degrade the instrument's EMC performance.

To avoid damages or burns, do not put the instrument in microwave ovens. For your and the instrument's safety, do not use or store the instrument in hazardous environments.

edge[®] blu enables the user to make fast, accurate pH measurements wirelessly using the Hanna Instruments HALO™ Bluetooth digital sensor. Each HALO™ probe has a unique serial number. Once connected to the meter, the probe is ready to measure pH along with temperature.

The user interface permits you to adapt edge[®] blu to your exact measurement requirements. The intuitive design simplifies configuration, calibration, measurement, data logging and transfer of data to a USB thumb drive or computer. edge[®] blu also offers a basic operation mode that streamlines measurement configuration and is useful for many routine applications. (Every feature and measurement detail is designed to give you an edge in measurement technology.) edge[®] blu is versatile in many ways. The slim meter and probe can be used as a portable device (using its rechargeable battery) or used in its bench or wall cradles (that also power the meter) as a line-powered laboratory instrument.

PRODUCT DIAGRAM

- Sleek, clean, intuitive design
- Bluetooth connectivity, extreme portability
- Internal clock and date
- Adjustable pH resolution
- Dedicated GLP key
- GLP data included with logged data
- Basic mode for simplified operation
- Simplified data transfer to a PC
- Up to 8 hour battery life when used as a portable device

Side & Back View

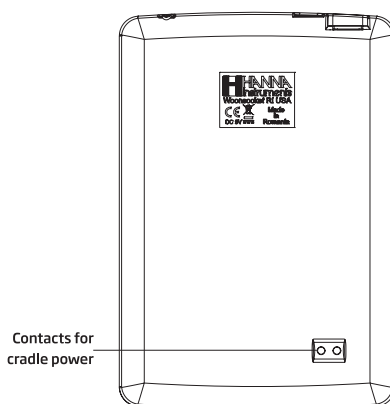
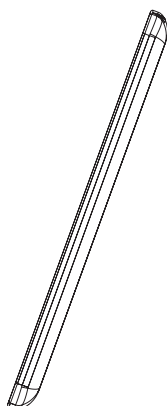

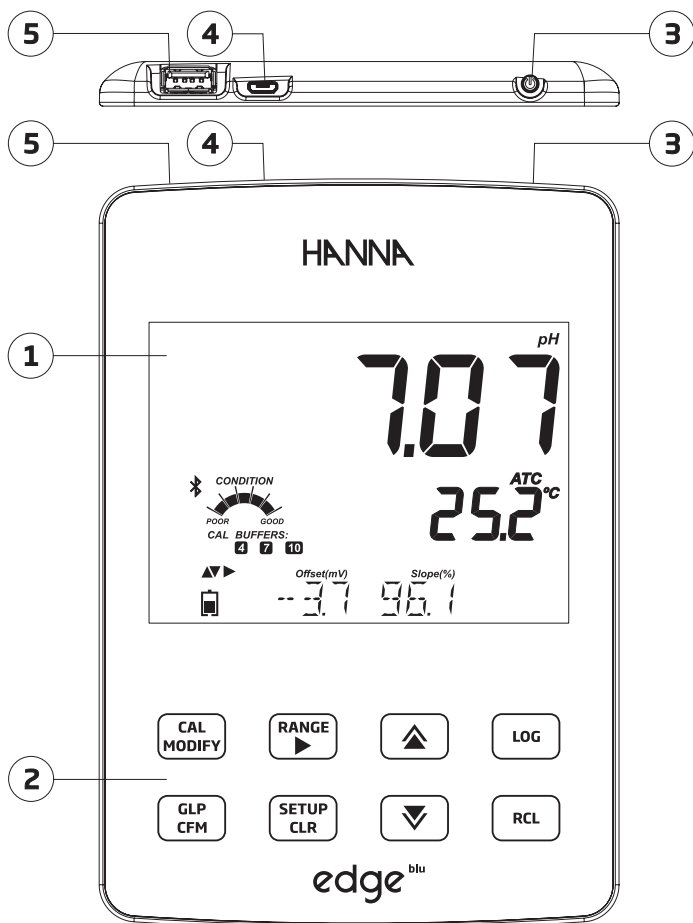

1. Liquid Crystal Display (LCD)
2. Capacitive Touch Keypad
3. Top mounted ON/OFF button
4. Micro USB device connection for power or PC interface
5. Standard USB host connection for data transfer to a USB thumb-drive

PROBE DIAGRAM

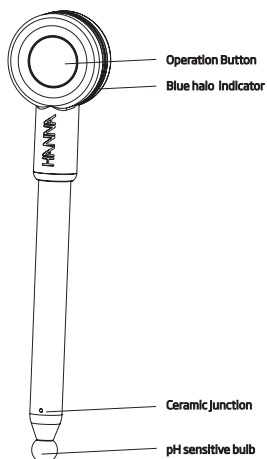

HI11102 HALO™ pH Probe with Bluetooth® Smart Technology

- Glass body, double junction, gel filled pH probe
- Auto sensor recognition
- Store calibration specific data from the last calibration
- Integrated temperature measurement
- Bluetooth connectivity processor
- Unique serial ID in every probe for traceability

GUIDE TO INDICATORS PROBE

The halo measurement state indicator

The blue halo indicator signal flashes in different patterns validating the change in probe status.

- 1) Advertising - Flash every $\frac{1}{2}$ second.
- 2) Connected to - 4-5 quick group of Flashes followed by normal operation.
- 3) Normal Operation - Flash every 2 seconds.
- 4) Upon Connecting - One small group of flashes followed by normal operation.
- 5) Shutdown sequence - Two fast flashes.
- 6) Shutdown due to battery failure - Three fast flashes.
- 7) Shutdown upon entering standby mode - Two sets of double fast blinks.
- 8) In standby mode - blue halo is off.

KEYPAD FUNCTION

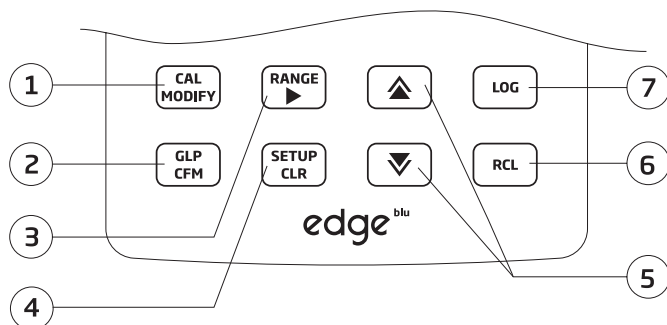

1. **CAL/MODIFY** - Used to enter and exit calibration mode. In SETUP, used to initiate changes of a configuration setting.
2. **GLP/CFM** - Used to display GLP calibration information. In SETUP, used to confirm change made. In calibration, used to accept calibration points.
3. **RANGE/▶** - Used in main screen to switch between pH display, mV display or MTC value edit (only for electrodes without temperature sensor e.g. [HI10832](#)). In SETUP, used to move to right in pick list. In log RCL, used to view GLP data for a data point.
4. **SETUP/CLR** - Used to enter/exit SETUP mode. During calibration, used to clear previous calibration data. In log RCL, used to clear log records.
5. **▼/▲** -Used to scroll through SETUP menu. Used to change selection when modifying a parameter in SETUP. Used to access Bluetooth Functions in measurement.
6. **RCL (Recall)** - Used to view logged records or view % log memory used.
7. **LOG** - Used to log data by manual log on demand or manual log on stability or to start/stop interval logging.

Note: Log can also be initiated or terminated by depressing the Operation button on probe.

You can increase/decrease the speed to change the value of a parameter.

Proceed as follows:

Press and hold down the ▼ or ▲ key, then slide the finger toward the double apex to increase the rate of value changes.



GUIDE TO INDICATORS INSTRUMENT

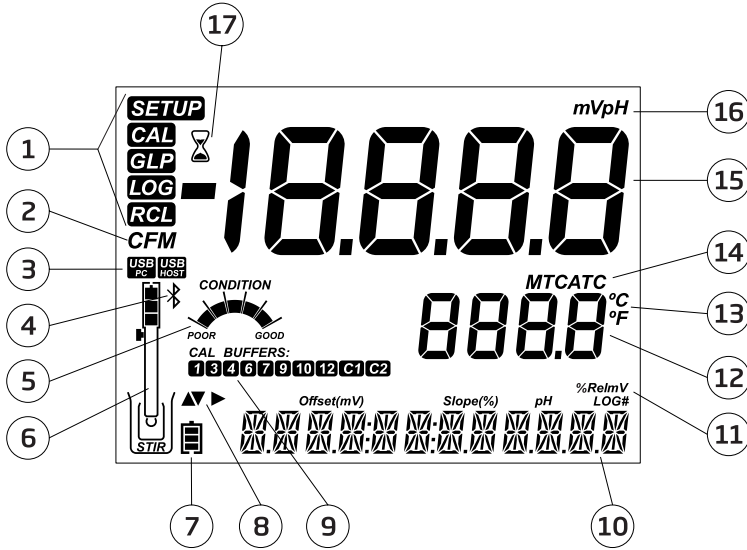

- | | |
|--|--|
| 1. Mode tags | 10. Third LCD line, message area |
| 2. Confirm tag | 11. Labels |
| 3. USB connection status | 12. Second LCD line, temperature measurement |
| 4. Bluetooth Logo | 13. Temperature units |
| 5. pH electrode diagnostics | 14. Temp. Compensation status |
| 6. Probes symbol with battery status | 15. Measurement line |
| 7. Battery symbol | 16. Measurement units |
| 8. Arrow tags, displayed when they are available | 17. Stability Indicator |
| 9. pH calibration buffers used | |

The third line of the LCD (10) is a dedicated message line. During measurement the user may use the \blacktriangledown \blacktriangle keys to select different functions. Options include scanning for, connecting to, identifying a connected probe, or displaying the date, time, calibration data or battery charge. If a measurement error or log status change occurs during measurement, the third line will display a pertinent message.

SETTING UP edge® blu

The main operating modes of edge® blu are setup, calibration, measurement, data logging, and data export. Follow this general outline of steps to get you started. The following topics are expanded upon in the sections that follow in this manual.

1. Familiarize yourself with the design features of this unique meter.
2. Decide how the meter will be used and set up the wall or bench cradle in a clean area near line power.
3. Turn edge® blu on using the ON/OFF button located on the top of the meter.
4. Turn ON the probe by pressing the button on the HALO™ probe and connect to the edge® blu through Bluetooth.
5. SETUP the measurement parameters required for the measurement you will be making.
6. Calibrate the sensor/probe.

You are now ready for measurements.

Bench Cradle Setup

Insert electrode holder arm into the post on the pivoting base.

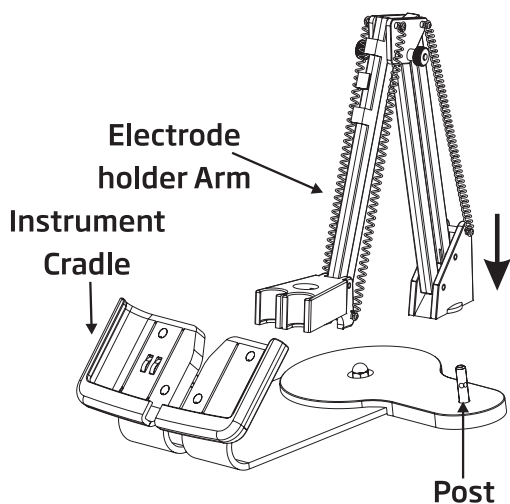

Slide **edge® blu** into the cradle. Put the probe into the electrode holder.

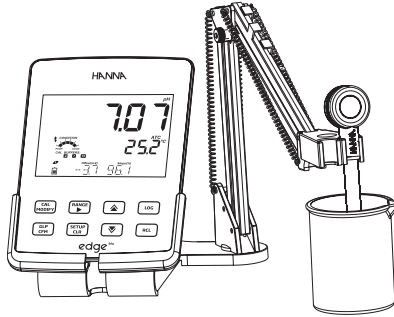

Connect the power adapter cable to the rear socket of the bench cradle. Connect the other end to the power adapter and plug into line power. Verify the battery icon indicates charging.

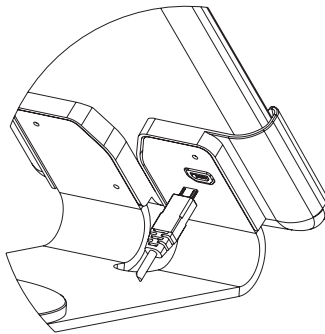

Wall Cradle Setup

Choose suitable wall location. (Use 2.5 mm or US #3 bit). Fasten the wall cradle using the provided screws. Snap cover over screw heads.

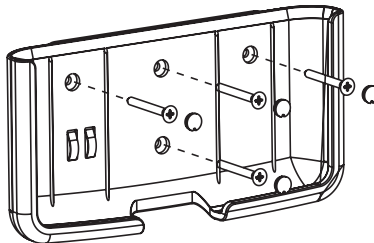

Connect the power adapter cable to the bottom socket of the wall cradle. Connect the other end to the power adapter and plug into line power.

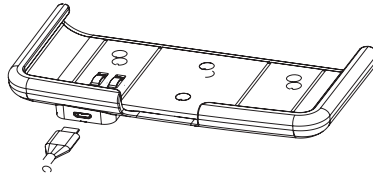

Slide **edge® blu** into the wall cradle. Verify the battery icon indicates charging.

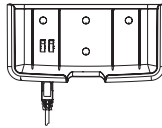
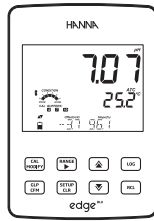

Power Connection

Alternatively to using the cradle for power, **edge® blu** can be powered by micro USB socket at the top. Plug the 5 VDC adapter into the power supply socket or by connecting directly to a PC.

Note: edge® blu is supplied with a rechargeable battery, which provides about 8 hours of continuous use. Whenever edge® blu is connected to the power adapter or to a PC, the battery is charging.

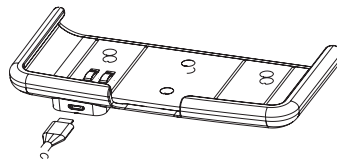
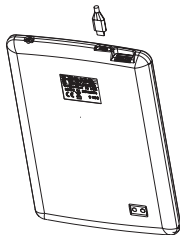

PROBE CONNECTIONS

At startup, **edge® blu** will perform the first scan, trying to discover any advertising HALO™ probe.



If during “SCANNING” the **SETUP/CLR** key is pressed the meter will jump to measurement screen and it will continue scanning in background.

If advertising probe are found, they will be shown immediately. The user can select a probe (**▼▲** keys) and connect to it using **GLP/CFM** key.



If the last connected probe is found, it will connect to it automatically.

If during “CONNECTING” the **SETUP/CLR** key is pressed, the meter will abort the current connection and display “CONNECTION TERMINATED”.



If an advertising probe is not found, after the scan is done, **edge® blu** will jump in the measure mode (with “NO PROBE” message).

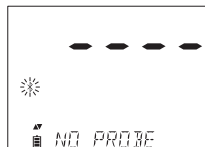

If later the meter finds an available probe it will display automatically “PROBES AVAILABLE”. In order to see the list of probes, press **GLP/CFM** key. To connect to a probe from the list, select the desired probe using the **▼▲** keys and press **GLP/CFM** key.



To perform a manual scan in measure mode, navigate to SCAN with **▼▲** keys and press **GLP/CFM** key. “SCANNING” will be continuously displayed until a probe starts advertising. Press **SETUP/CLR** key to return to measure mode.

Error messages may be displayed while connecting HALO™ to **edge® blu**. These may be due to bluetooth signal strength, or probe configuration.

After the connection is established, **edge® blu** will read the probe configuration. If the probe is not compatible with the current version of the meter, the message “INCOMPATIBLE PROBE” will be displayed. In the case of a probe with corrupted data, the meter will show “BAD PROBE” or “PROBE NOT CONFIGURED”. In these cases, please contact your local Hanna Instruments Office.

Note: When the scanned probes are shown, they are ordered by the RSSI (signal strength) in descending order. The list shows changes dynamically, but the current probe should always maintain on screen.

GENERAL SETUP

The following Setup options are displayed regardless of the sensor being used or without a sensor. These settings remain when switching to another probe. Options are tabulated in the table below with choices and default values. Options are accessed by pressing SETUP. Use ▼ ▲ keys to go through Setup functions in order indicated in the table below. To modify a setting, press **CAL/MODIFY** key. The option may be modified by using **RANGE/**, ▼ and ▲ keys. Press **GLP/CFM** key to confirm the change. To exit SETUP press **SETUP/CLR** key.

Option	Description	Choices	Default	Basic Mode
*Only seen when cable connection between micro USB and PC is made.	Select if PC is being used for charging battery (and meter will be used for logging) or if Data will be exported to the PC.	LOG ON EDGE or EXPORT TO PC	LOG ON EDGE	Available
Log	Select log type to be used from 3 types of logging: Manual log on demand Manual log on stability (3 types of stability criteria available) Timed interval lot logging	Manual log Stability log: Fast, Medium, Accurate; Interval log: Seconds: 5, 10, 30; Interval log Minutes:1, 2, 5, 15, 30, 60, 120, 180.	Interval (5 sec)	Manual log or Stability log: Medium
Set Calibration Expiration Warning	Meter will indicate "CAL DUE" when set time in this parameter has been exceeded.	1, 2, 3, 4, 5, 6, 7 days or OFF	7 days	Not available
Basic Mode	When "On", a limited set of parameters and calibration buffers are available for use.	Off or On	Off	Available
Information	Visual indication of buffers used, Probe Condition is displayed when calibration uses 7.01 and 4.01 and/or 10.01/9.18 pH buffers.	Off or On	On	Buffers used, probe conditions are not displayed.

Option	Description	Choices	Default	Basic Mode
First Custom Buffer	When “On”, it permits the user to enter a custom pH buffer value to use during electrode calibration.	Off or value	Off	Not Available
Second Custom Buffer	When “On”, it permits the user to enter a custom pH buffer value to use during electrode calibration.	Off or value	Off	Not Available
First Calibration Point	Allows the user to choose how the first point in calibration will be made.	Offset or point	Offset	Not Available (automatically uses Offset)
Resolution	Allows the user to select between 0.01 and 0.001 pH resolution.	0.01 or 0.001pH	0.01 pH	Not Available (automatically uses 0.01pH resolution)
Set Out Of Calibration Range	When set to “On”, a measurement that is outside the calibrated range (buffers used) will trigger a warning message.	Off or On	On	Not Available, No error messages displayed.
Set Date	Press CAL/MODIFY key to Set current date, displayed in ISO format. Press GLP/CFM key to save changes.	YYYY/MM/DD Date	Set date	Available
Set Time	Press CAL/MODIFY key to Set current time, displayed in ISO format. Press GLP/CFM key to save changes.	24 hr:MM:SS Time	Set time	Set time
Set Auto Off**	Used to save battery life by automatically turning off when no key press is detected for time set and the meter is not active in logging or calibration mode.	5, 10, 30, 60 Min or Off	10 MIN	Available
Sound	If enabled, a short audible tone is produced for key stroke or calibration confirmation and a longer tone for wrong key.	On or Off	On	Available

Option	Description	Choices	Default	Basic mode
Temperature Unit	Select degree Celsius or Fahrenheit scale for displayed and logged temperatures.	°C or °F	°C	Available
LCD Contrast	Permits modification of the display contrast for various lighting conditions.	0 to 7	3	Available
Flash Format*	Permit formatting the flash drive.	On or Off	OFF	Available
Message Transition	User may choose how messages are displayed on third LCD line of display.	Word scroll messages or letter scroll messages.	Letter scroll messages	Available
Reset Config to Default	Press CAL/MODIFY key and GLP/CFM key (when prompted) to reset parameters.			Available: RESETS with Basic Mode OFF
Instrument Firmware/ Probe Firmware/	Displays firmware version of meter. Using the RANGE/▶ key switches to Probe firmware (if connected) and diagnostic made for troubleshooting.	View only	Current firmware version	Available
Meter ID/ Meter SN/ Probe SN	User ID and Serial Number of meter and probe(if connected). Use RANGE/▶ key to change between the three parameters.	Meter ID is user selectable.	0000/Serial Number	Available
CSV file separator	Used to separate columns in the CSV file.	Comma(,) Semicolon(,)	Comma	Available
Probe disconnect mode	Select if probe will be shut down and disconnect or sent to standby mode, with slow advertising. Only for probes V1.01 or above.	Shutdown or Standby	Shutdown	Available

*Note: Options that are seen under special conditions only.

**Note: Auto Off is disabled when the edge[®] blu meter is connected to a PC.

pH CONFIGURATIONS

Once a HALO™ probe is connected to a meter, all Probe specific parameters will be visible in the SETUP menu.

edge's pH meter operation is configured by using the **SETUP/CLR** key with a pH probe connected to the meter. The parameter-specific options will be seen inserted into the menu. If Basic mode is "On", the pH parameter list will not be displayed. See Basic mode for a description of this operation before choosing how to SETUP the meter.

BASIC MODE

edge®^{blu} offers a basic operation mode that streamlines measurement configuration for pH measurements and is useful for many routine applications. Basic pH SETUP reduces parameter selection to the basic set. The meter limits calibration to 5 standard pH buffers: pH 6.86, 7.01, 4.01, 9.18 and 10.01 buffers. All pH measurements will display, log and export with 0.01 pH resolution. Interval logging is also eliminated. Manual and Manual medium stability log on demand are still functional. pH CONDITION graph is not displayed, giving the display a "Basic" measurement screen with just pH data and temperature.

LOGGING FUNCTION

Note if powering edge^{blu} through the micro USB connector to a PC, a SETUP option will require the choice "LOG ON EDGE" or "EXPORT TO PC".

1000 log records can be stored into edge^{blu} memory. This memory is shared between all logging types (Manual, Manual Stability, Interval logs).

The maximum number of records for an Interval lot is 600 records (provided log space is available).

A record is a stored reading and a lot is a group of records.

Each time an Interval log is initiated, a new lot is created. The maximum number of Interval lots that may be stored is 100. If a 101st lot is attempted, "MAX LOTS" will be displayed. Some lots will need to be deleted. The lot numbering is up to 999 and restarts if all lot logs are deleted. All log on demand and stability log on demand are stored in a single lot. The maximum number of records that may be stored in a Manual or Stability lot is 200 records. If the log memory is full during any logging session, the "LOG FULL" message will be displayed on the third LCD line for a brief moment and logging will cease. The display will return to the measurement screen.

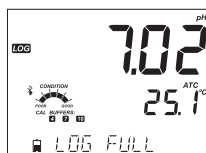

Logging type is configured in SETUP.

Types of Logging

Interval logging: A continuous log recorded using a user-selected timed period. (This is not available in Basic mode).

Manual log on demand: Readings are logged each time **LOG** key is pressed. All of the records are stored in a single Manual lot for the measurement type. New records made on different days are stored in the same Manual lot.

Manual Stability log on demand: A log on demand that is made each time **LOG** key is pressed and the stability criteria is reached. Stability criteria may be set to Fast, Medium or Accurate settings. In Setup mode, choose log parameter, press **CAL/MODIFY** key then use the **RANGE/▶** key to select between Interval, Manual, or Stability. When Interval is displayed, use the **▼** and **▲** keys to select the setting for the timed interval. When Stability is displayed, use the **▼** and **▲** keys to select the measurement stability setting.

A complete set of GLP information including date, time of log, pH (mV), temperature reading, calibration information and probe serial number is stored with each log made.

Interval Logging

Select Interval and sampling period in the SETUP menu (Not available in Basic mode). To start Interval logging, press the **LOG** key while the instrument is in measurement mode, or short press the probe button.

A "PLEASE WAIT" message will be displayed followed by the number of free spaces. During active interval logging, lot information is displayed on the third LCD line. The line indicates in which lot the data will be placed and keeps track of the number of logged records taken. The "LOG" tag is on continuously during active logging.

Pressing **RANGE/▶** key during an interval log will display the number of logs available.

Pressing the **LOG** key, or the probe button again will stop the Interval logging session. The "LOG STOPPED" message will be displayed for a few seconds.

If a sensor failure occurs during interval logging, the message "OUT OF SPEC." will alternate with logging information.

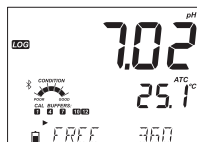
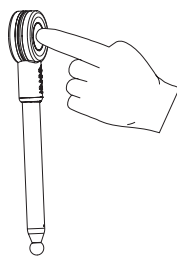

Manual Logging

Select Manual in the SETUP menu. To initiate a Manual log, press the **LOG** key, or the probe button while the instrument is in measurement mode. The “PLEASE WAIT” screen will be displayed briefly followed by a screen indicating the measurement has been saved and then a screen indicating the log record number.

The “LOG” tag will be displayed on all 3 screens.

“PLEASE WAIT”

“SAVED” with the log record number

“FREE” with the number of free spaces available

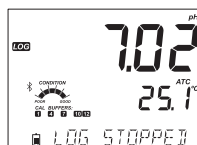

Stability Logging

Select Stability and choose measurement stability criteria in the SETUP menu. Only Stability Medium is available in Basic mode. To initiate the Stability log, press the **LOG** key, or the probe button while the instrument is in measurement mode.

The “PLEASE WAIT” screen will be displayed briefly followed by a screen showing the stability tag, “LOG” tag and a “WAITING” message. The log can be stopped while the “WAITING” message is displayed by pressing **LOG** key, or the probe button again.

When the stability selected criteria has been met, a “SAVED” message will be displayed followed by a screen indicating how much log space is available. The “LOG” tag will be displayed on all 4 screens.

The messages below will also be displayed in certain cases:

“PLEASE WAIT”

“WAITING”

“SAVED” with the log record number

“FREE” with the number of free spaces available

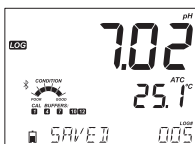
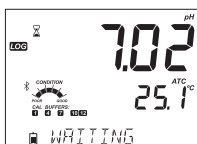
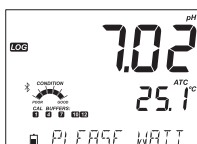
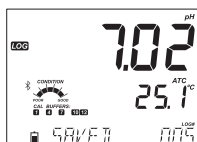

VIEWING LOGGED DATA

All log records stored on **edge[®] blu** may be viewed on the meter by pressing the **RCL** key.

The display indicates the percentage of log memory used. Press **GLP/CFM** key to display the logs.

Choices are:

- Manual log on demand lot,
- Manual log on stability lot,
- Individual Interval logging lots.



If no data was logged for the selected log type, the instrument displays the following messages (ex. for pH range):

- "NO MANUAL LOGS"
- "NO STABILITY LOGS"
- "NO INTERVAL LOGS"

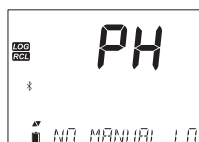

Press **GLP/CFM** key to enter inside lot information to view recorded data.

Use the **▼ ▲** keys to toggle between different records.

Use **RANGE/▶** key to display GLP data including calibration information, time and date of the log etc.

Press **CLR** key then **GLP/CFM** key when deleting records or lots.

Press **RCL** key to exit the logging type.

Press **RCL** key to exit the parameter selection screen.

Press **RCL** key to return to the measurement screen.



Delete Logging Type/Lot

Press **RCL** key. pH, Log Recall will be displayed. Press **GLP/CFM** key.

Use the **▼ ▲** keys to select the Manual/Stability records or Interval lots to delete.

Press **SETUP/CLR** key. The instrument will display "CLEAR MANUAL" for Manual Records, "CLEAR STAB" for Stability Records.

For Interval lots, the message "CLEAR", followed by the selected lot will be displayed with "CFM" tag blinking.



Press the **▼ ▲** keys to select a different lot. Press **GLP/CFM** key. The instrument will display "PLEASE WAIT".



“CLEAR DONE” is displayed for a few seconds after the selected Interval lot is deleted.



Delete Log Records

Delete Records (Manual and Stability log on demand)

To delete individual records (Manual and Stability logs only), enter Manual (Stability) log by pressing **GLP/CFM** key when Manual (Stability) is displayed. Use the ∇/\blacktriangle keys to select the record to be deleted and then press **SETUP/CLR** key.

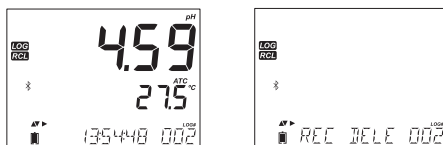

The instrument will display “REC DELETED PRESS CAL TO UNDO”, or RCL to save changes and no measure values will be shown. Multiple records can be deleted. To recover the deleted records, press **CAL/MODIFY** key for each deleted record.

Press **RCL** key to save and exit the manual or stability log. The instrument will display “SAVING” for several seconds. When individual logs are deleted within saved **MANUAL** or **STABILITY** logs, the logs will renumber, filling in the deleted data but staying in chronological order.

To delete all records of the **MANUAL (STABILITY)** log, proceed as described on page 20 for **LOTS**.

Select the Manual (Stability) lot and press **SETUP/CLR** key. The “CLEAR” message will be displayed along with “MANUAL” or “STABILITY” and “CFM” tag blinking on the LCD. Press the **GLP/CFM** key to confirm the deleting of the selected lot (**MANUAL** or **STABILITY**) or all records. Press **SETUP/CLR** key to exit without deleting.



The lot number is used to identify particular sets of data. The lot numbers are allocated successively until 100, even if some lots were deleted. The total number of lots that can be saved is 100. If some are deleted (for example 1-50), fifty additional logs may be stored. These will be numbered 101-150. The lots are allocated successively (provided available memory space) until 999 is reached. After this, it is necessary to delete all the **LOT** logs. Numbering will begin in with 001.

Delete All

All pH logs, may be deleted in a single clear. This function will delete all **MANUAL**, **STABILITY** and **INTERVAL** logs.

Press the **RCL** key. “CFM” will be blinking.



While the pH is displayed and “CFM” blinks and message states “LOG RECALL”, press **SETUP/CLR** key.

“CLEAR ALL” and pH will be displayed with “CFM” tag blinking. Press **GLP/CFM** key.



“PLEASE WAIT” and the percent cleared will be displayed until completed.

Note: If SETUP/CLR key is pressed in error, press SETUP/CLR key again to exit without deleting.

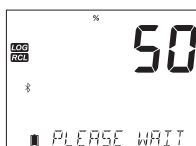

“CLEAR DONE” will appear after the records were erased successfully.



PC & STORAGE INTERFACE

Logged data on **edge® blu** can be transferred from the meter to a USB flash drive by using the log recall function. The minimum requirement for the drive is USB 2.0.

Follow the simple steps below.

Connect USB flash drive to the USB port, located on the top of the meter.

Press the **RCL** key. Press **GLP/CFM** key at pH screen.

Select Manual, Stability, or interval lots by using the **▼▲** keys.

Press the **LOG** key (not **GLP/CFM** key). The “USB HOST” tag should come on.



“PLEASE WAIT” message appears followed by “EXPORT”. Press

GLP/CFM key to export the selected record or lot. If **GLP/CFM** key is not pressed in 10 seconds, the USB host will become inactive.



The meter will display the percentage of export.

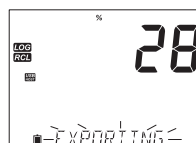

The export percentage should go to 100%. Remove USB flash drive.

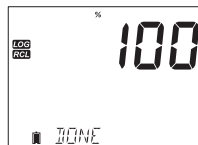

If the selected file or a file with the same name, is already saved on the flash drive, **edge[®] blu** will ask for confirmation of overwriting the existing file. The message "OVERWRITE" and "CFM" tag will blink. Press **GLP/CFM** key for overwriting the existing file or **CAL/MODIFY** key to exit without exporting.



Exporting All Logs

After exporting the display will return to the selected file. Press the RCL key twice to return to measurements.

In order to export all logs from the meter, enter Log Recall. The meter will display percentage of occupied memory. Connect USB flash drive to the USB port located on the top of the meter.



If the percentage is not 0.0%, the user can press **LOG**, and the Export All menu is shown. After the user confirmation, the USB host is activated and the memory stick gets powered. **edge[®] blu** will start to copy to the USB stick all the available logs.



If the files already exist on the USB stick, the meter will prompt the "OVR" and lot number message.

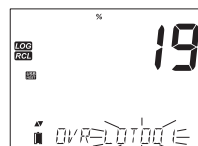

The meter will give four options for overwrite operations: YES, NO, YES ALL and NO ALL. These options can be selected using the **▼▲** keys and then confirmed by pressing **GLP/CFM** key.

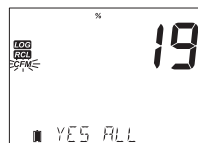

Note: Do not remove USB flash drive during an active export transfer. Recharge the battery and then export if "BATTERY TOO LOW TO EXPORT" message appears.

Logged data on the **edge[®] blu** can be transferred from the meter to a PC by following these simple directions. Suitable operating systems include Windows (XP minimum), OS X or Linux.

1. Connect **edge[®] blu** to the PC using the supplied micro USB cable.
2. Turn on **edge[®] blu**.
3. Press **SETUP/CLR** key and select "LOG ON EDGE".
4. Press **CAL/ MODIFY** key then use **▼ ▲** keys to change to "EXPORT TO USB".
5. Press **GLP/CFM** key and the USB/PC Tag is displayed.
6. Press **SETUP/CLR** key to exit.

The PC should detect the USB as a removable drive. Open the drive to view the stored files. Log files are formatted as Comma separated values (*.CSV) and can be opened with any text editor or spreadsheet program.

Note: Field separator may be set as comma or semicolon depending upon region preferences, see Setup.

Western Europe (ISO-859-1) character set and English language are suggested settings. Other files may be visible depending upon computer settings. All files stored will appear in this folder. Adjust font or column width appropriately. Adjust the decimal places if the pH was logged with 0.001 resolution.

Interval logs are designated as pH. ie. PHLOT001, PHLOT002 etc.

The Manual Lots are PHLOTMAN, and the Stability Lots are PHLOTSTA. All stability logs, regardless of stability setting, are located in the same stability file.

Click on the desired log to view data.

Note: If "°C !" appears in log data, the electrode/probe was used beyond it's operation specifications and the data is not considered reliable.

If "°C !!" appears in log data, the temperature sensor within the probe or electrode is broken and the device should be replaced. Logged data should not be considered reliable.

For optimum pH measurements, details follow below:

1. Understand the benefits and features of Standard and Basic Operation.
2. Connect the HALO™ probe to the **edge[®] blu**.
3. Set up **edge[®] blu** meter by configuring preferences.
4. Calibration.
5. Measurement.

BASIC VS. STANDARD pH MODE

The “Standard” pH operation includes up to a 5-point buffer calibration, use of custom buffers, choice of displaying 0.001 pH resolution, use of the full diagnostic features of Calibration Check™ (that includes buffers used, probe condition and messages indicating a contaminated buffer or pH sensor requiring maintenance during calibration).

The Standard pH operation also includes full logging capability including Interval, Manual log on demand and Manual log on stability.

“Basic” pH operation provides a simplified SETUP menu; there are no decisions to make regarding the pH measurement itself.

The meter will display 0.01 pH resolution and permit a 3-point buffer calibration from the following pH buffers; pH 4.01, 6.86, 7.01, 9.18 or 10.01. Calibration Check™ features are limited to messages during calibration. Calibration reminders are also not available. The GLP will still provide offset, slope, buffers used and a calibration date. The Basic pH operation includes Manual log on demand and Manual log on stability (medium setting).

Note: When changing from Standard to Basic operation in SETUP, previous calibration data will be cleared. A prompt will force the user to facilitate this.

Major differences between Standard and Basic modes are shown below.

	Standard	Basic
Calibration	5 points including 2 custom buffers	3 points
Diagnostics	Cal Check™ Feature Error messages GLP	Basic error messages GLP basic
Log types	Manual Log on demand Manual Log on stability (Fast, Medium, Accurate) Interval Logging	Manual Log on demand Manual Log on stability (Medium)

CONNECTING THE HALO™ PROBE

Power the *edge*®*blu* meter by pressing the ON/OFF button on the top of the meter. The Bluetooth logo and “SCANNING” will appear in the message area. Immediately press the operation button on your HALO™ probe. The blue halo on the probe will start blinking every half second indicating it is in discoverable mode. If this is the first connection to the probe, and is the only HALO™ in discoverable mode, the message will change to “CONNECTING” and the probe model will appear, followed by a cap removal reminder and then the measurement screen.

If more than one probe is available, the desired probe must be selected (▼ ▲) and confirmed to connect (GLP/CFM key). If a previously associated probe is in STANDBY or in discoverable mode when scanning, the meter will automatically connect to that probe.

pH CALIBRATION

Calibration in Standard Mode

pH operation in standard mode offers full function of *edge*®*blu*. This includes seven standard buffers and two custom ones. Five pH buffers may be used for calibration.

The instrument should be recalibrated whenever:

- High accuracy and sensor verification are required.
- The filling solution of the electrode is replaced (refillable probes only).
- At least once a week.
- After testing aggressive chemicals.
- If “CAL DUE” is displayed on the third LCD line.

Every time you calibrate the instrument use fresh buffers and perform electrode maintenance as required. It is advised to choose calibration buffers that bracket the sample pH.

Preparation

Pour small quantities of the buffer solutions into clean beakers. If possible, use plastic to minimize any EMC interferences. For accurate calibration and to minimize cross-contamination, use two beakers for each buffer solution; one for rinsing the electrode and one for calibration. If you are measuring in the acidic range, use pH 7.01 or 6.86 as the first buffer and pH 4.01 as the second buffer. If you are measuring in the alkaline range, use pH 7.01 or 6.86 as first buffer and pH 10.01 or 9.18 as the second buffer.

Procedure

Calibration can be performed using up to five calibration buffers. For accurate measurements, a minimum of a three-point calibration is recommended. The calibration buffer can be selected from the calibration buffer list that includes the custom buffers and the standard buffers:

pH 1.68, 4.01, 6.86, 7.01, 9.18, 10.01 and 12.45.

The custom buffers allow the user to calibrate in a buffer solution different from a standard one. Two custom buffers can be set in SETUP menu. See page 28 for more information about using custom buffers.

The instrument will automatically skip custom buffers which are in a ± 0.2 pH window of an already calibrated buffer.

Submerge the pH electrode approximately 3 cm (1¼") into a buffer solution and stir gently. Press **CAL/MODIFY** key to enter calibration.

The "CAL" tag will appear and the "7.01" buffer will be displayed on the third LCD line. If necessary, press the \blacktriangledown / \blacktriangle keys to select a different buffer value. The "☒" along with "STIR" tag will be displayed and "WAIT" will blink on the LCD until the reading is stable.

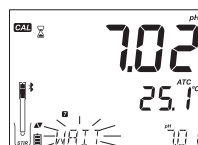

When the reading is stable and close to the selected buffer, "CFM" tag will blink. Press **GLP/CFM** key to confirm calibration.

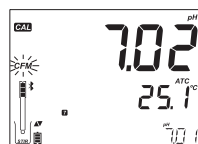

After confirming the first point, the calibrated value will be displayed on the first LCD line and the second expected buffer value on the third LCD line (i.e. pH 4.01).

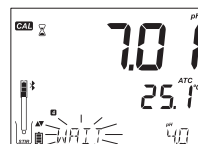

Rinse and submerge the pH electrode approximately 3 cm (1¼") into the second buffer solution and stir gently. If necessary, press the \blacktriangledown / \blacktriangle keys to select a different buffer value.

The "☒" along with "STIR" tag will be displayed and "WAIT" will blink on the LCD until the reading is stable.

When the reading is stable and close to the selected buffer, "CFM" tag will blink. Press **GLP/CFM** key to confirm calibration.

Repeat procedure with additional pH buffers. A total of five pH buffers can be utilized.

After confirming the last desired buffer calibration points, press **CAL/MODIFY** key (or if all five buffer values were calibrated) the instrument will automatically display "SAVING" as it stores information. It will then return to normal measurement mode.

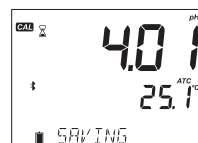

Each time a buffer is confirmed, the new calibration data replaces the old data for the corresponding buffer or for any buffer in the proximity of ± 0.2 pH.

If current buffer has no previous data stored and the calibration is not full (five buffers), the current buffer is added to the existing calibration. If the existing calibration is full, the instrument asks which buffer to replace.

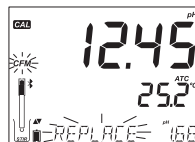

Press the \blacktriangledown \blacktriangle keys to select another buffer to be replaced.

Press the **GLP/CFM** key to confirm the buffer that will be replaced.

Press the **CAL/MODIFY** key to leave calibration without replacing.

Note: If the replaced buffer is outside the ± 0.2 pH window of the calibrated buffers, it is possible to select this buffer during the next calibration.

Working With Custom Buffers

If a custom buffer was set in SETUP menu, it can be selected during calibration by pressing the

\blacktriangledown \blacktriangle keys. The "C1" or "C2" tag will be displayed once selected.

Press **RANGE/▶** if you want to modify the custom buffer value. The buffer value will start blinking.

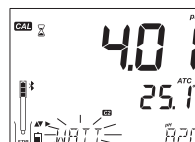

Use the \blacktriangledown \blacktriangle keys to change the buffer value. After 5 seconds, the buffer value is updated. Press **u** if you want to change it again.

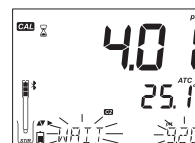

Note: Custom buffer values can be adjusted ± 1.00 pH around the set value during calibration. When a custom buffer is displayed, the "C1" or "C2" tag is displayed.

First Calibration Point

When performing a new calibration, or adding to an existing one, the user has a choice of how the first new calibration point will be treated in reference to the existing calibration point. This is selected in SETUP by the option FIRST CALIBRATION POINT. The two SETUP selectable options are "POINT" or "OFFSET".

Point: A buffer value can be recalibrated and added to the previous calibration set. The electrode slope of the other calibration points will be reevaluated with the recalibrated buffer value.

Offset: The new buffer calibration point can create a constant offset to all existing pH calibration data (existing calibration must have a minimum of two pH buffers).

Recalibrating a pH sensor or adding to an existing calibration is simple and follows the PROCEDURE outlined on page 26.

Press **CAL/MODIFY** key. Place sensor in desired buffer and select buffer from choices. When sensor has equilibrated, the CFM tag will turn on and blink. Press the **GLP/CFM** key.

Press **CAL/MODIFY** key to escape the calibration. Alternately continue calibrating in additional buffers. The latest calibration point will be added to the existing data. GLP will reflect the latest calibration data. Older calibration buffers will be seen as blinking buffers.

Note: Each time a buffer is confirmed, the new calibration data replaces the old data for the corresponding buffer or for any buffer in the proximity of ± 0.2 pH. If the current buffer has no previous data stored and the calibration has not used five buffers, the current buffer is added to the existing calibration. If the existing calibration is full, the instrument asks which buffer to replace. When using Standard mode, the user can choose if they want the display to show CONDITION gauges on the display. These are part of the Cal Check™ system and are selected in SETUP by the option INFORMATION. The choice is ON or OFF.

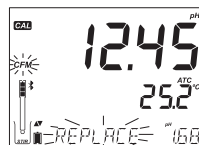

Electrode Condition

edge®^{blu} pH Calibration Check™ feature will assess electrode condition during each calibration and display it for the rest of the day.

The condition gauge shows the electrode’s condition that is based on the offset and slope characteristics of the pH electrode at the time of calibration. This gauge reflects the electrode’s performance and should be expected to slowly decrease over the life of the electrode.

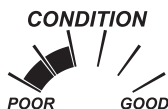

If the instrument is not calibrated the calibration history has been deleted, or it has been calibrated only at one point, the electrode condition gauge will be empty.



For a continuous display of the electrode's condition, daily calibration is necessary. This information can also be viewed in the GLP data.

Calibration in Basic Mode

Procedure

Basic mode operation permits up to three-point buffer calibration.

For accurate measurements, at least a two-point calibration is recommended. However, a single point calibration can also be used.

The calibration buffers can be selected from the calibration buffer list that includes the standard buffers, pH 4.01, 6.86, 7.01, 9.18 and 10.01.

Three-Point Calibration

Submerge the pH electrode approximately 3 cm (1¼") into a buffer solution and stir gently. Press **CAL/MODIFY** key. The "CAL" tag will appear and the "7.01" buffer will be displayed on the third LCD line. If necessary, press the **▼ ▲** keys to select a different buffer value.

The "⌘" along with "STIR" tag will be displayed and "WAIT" will blink on the LCD until the reading is stable.

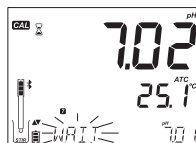

When the reading is stable and close to the selected buffer, the "CFM" tag will blink. Press **GLP/CFM** key to confirm calibration.

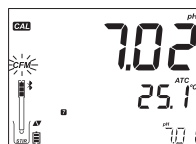

After confirming the first calibration point, the calibrated value will be displayed on the first LCD line and the second expected buffer value on the third LCD line. (i.e. pH 4.01)

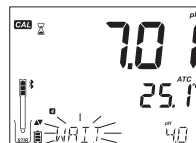

Rinse and submerge the pH electrode approximately 3 cm (1¼") into the second buffer solution and stir gently.

If necessary, press the **▼ ▲** keys to select a different buffer value.

The "⌘" along with "STIR" tag will be displayed and "WAIT" will blink on the LCD until the reading is stable. When the reading is stable and close to the selected buffer, the "CFM" tag will blink. Press **GLP/CFM** key to confirm calibration.

The calibrated value is then displayed on the first LCD line and the third expected buffer value on the third LCD line.

After the second calibration point is confirmed, rinse and submerge the pH electrode approximately 3 cm (1¼") into the last buffer solution and stir gently.

If necessary, press the ▼ ▲ keys to select a different buffer value.

The "⌘" along with "STIR" tag will be displayed and "WAIT" will blink on the LCD until the reading is stable.

When the reading is stable and close to the selected buffer, the "CFM" tag will blink. Press **GLP/CFM** key to confirm calibration.

At the end of calibration the instrument displays "SAVING", stores the calibration value and returns to normal measurement mode.

The calibration sequence may be reduced to two buffer values or a single one. Press **CAL/MODIFY** key to return to measurement mode after the desired number of buffers have been calibrated.

Note: When performing a new calibration or adding to an existing calibration the first calibration point will be treated as an offset. See page 28 for details.

Press CAL/MODIFY key after the first or second calibration point are confirmed and the instrument will store the calibration data. Then it will return to measurement mode.

If the value measured by the instrument is not close to the selected buffer, "WRONG BUFFER" will blink. Check if the correct buffer has been used, or selected. If measured value differs more than expected value "CHECK ELECTRODE CHECK BUFFER" will be displayed. Take appropriate action, cleaning the probe if necessary and refreshing the pH buffer.

If the buffer temperature exceeds the temperature limits of the buffer, "WRONG BUFFER TEMPERATURE" will be displayed.

Press SETUP/CLR key after entering calibration to clear previous calibrations stored on probe. "CLEAR CALIBRATION" message will be displayed. Press GLP/CFM key. The instrument will return to measurement mode displaying the "CAL DUE" message.

pH Buffer Temperature Dependence

Calibration buffers are affected by temperature. During calibration with standard pH buffers (not Custom), the instrument will display the pH buffer value at 25 °C, however, it will use the value for that buffer at the temperature of calibration. Immediately after exiting calibration, the buffer will read its value at the temperature of measurement.

TEMP		pH BUFFERS							
°C	°F	1.679	3.000	4.010	6.862	7.010	9.177	10.010	12.454
0	32	1.670	3.072	4.007	6.982	7.130	9.459	10.316	13.379
5	41	1.670	3.051	4.002	6.949	7.098	9.391	10.245	13.178
10	50	1.671	3.033	4.000	6.921	7.070	9.328	10.180	12.985
15	59	1.673	3.019	4.001	6.897	7.046	9.273	10.118	12.799
20	68	1.675	3.008	4.004	6.878	7.027	9.222	10.062	12.621
25	77	1.679	3.000	4.010	6.862	7.010	9.177	10.010	12.450
30	86	1.683	2.995	4.017	6.851	6.998	9.137	9.962	12.286
35	95	1.688	2.991	4.026	6.842	6.989	9.108	9.919	12.128
40	104	1.693	2.990	4.037	6.837	6.983	9.069	9.881	11.978
45	113	1.700	2.990	4.049	6.834	6.979	9.040	9.847	11.834
50	122	1.707	2.991	4.062	6.834	6.978	9.014	9.817	11.697
55	131	1.715	2.993	4.076	6.836	6.979	8.990	9.793	11.566
60	140	1.724	2.995	4.091	6.839	6.982	8.969	9.773	11.442
65	149	1.734	2.998	4.107	6.844	6.987	8.948	9.757	11.323
70	158	1.744	3.000	4.123	6.850	6.993	8.929	9.746	11.211
75	167	1.755	3.002	4.139	6.857	7.001	8.910	9.740	11.104
80	176	1.767	3.003	4.156	6.865	7.010	8.891	9.738	11.003
85	185	1.780	3.002	4.172	6.873	7.019	8.871	9.740	10.908
90	194	1.793	3.000	4.187	6.880	7.029	8.851	9.748	10.819
95	203	1.807	2.996	4.202	6.888	7.040	8.829	9.759	10.734

CALIBRATION MESSAGES

The Calibration Check™ feature may flag diagnostic messages during a calibration. As electrode aging is normally a slow process, substantial changes from previous calibrations are likely due to a temporary problem with the probe or buffers that can be addressed easily. These messages are seen in Standard and Basic modes.

Wrong Buffer

This message appears when the difference between the pH reading and the value of the selected buffer is too great. If this error message is displayed, check if you have selected the proper calibration buffer and have poured the desired buffer.

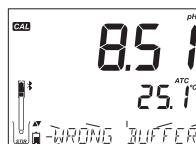

Wrong Old Points Inconsistency

“WRONG OLD POINTS INCONSISTENCY” is displayed if the new calibration differs significantly from the last value of that probe in that buffer. In this case it may be best to clear the previous calibration and attempt a new calibration with fresh buffers.

To clear calibration information, press **CAL/MODIFY** key then press **SETUP/CLR** key. The “CLEAR CALIBRATION” message will be displayed. Either press the **GLP/CFM** key and clear all calibration information or press **CAL/MODIFY** key to exit. Probe may retain a single point cal if first point was accepted.

Once calibration information is cleared, the message “CAL DUE” will be displayed.

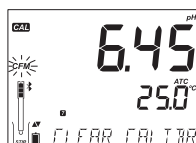
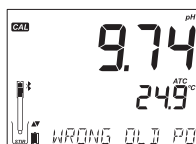

Clean Electrode

“CLEAN ELECTRODE” indicates poor electrode performance (offset out of accepted window, or slope under the accepted lower limit). Often, cleaning the probe will improve the pH electrodes response. See pH Electrode Conditioning and Maintenance for details. Repeat calibration after cleaning.

Check Electrode Check Buffer

“CHECK ELECTRODE CHECK BUFFER” appears when electrode slope exceeds the highest accepted slope limit. You should check your probe and use fresh buffer. Cleaning may also improve this response.

Bad Electrode

“BAD ELECTRODE” appears if the cleaning procedure performed as a result of the above two messages is found to be unsuccessful. In this case it is advised to replace the probe.

Wrong Buffer Temperature

“WRONG BUFFER TEMPERATURE” appears if the temperature of the buffer is outside the defined buffer temperature range. The calibration buffers are affected by temperature changes in a defined manner.

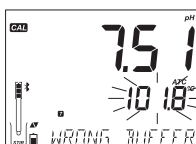
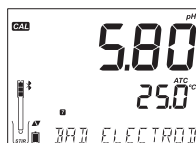
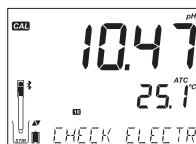
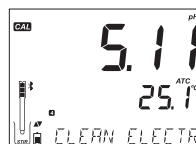

During calibration, the instrument will automatically calibrate to the pH value corresponding to the measured temperature but display it to the value at 25 °C. Immediately after calibration, the buffer should read the value of the buffer at the temperature of measurement.

Note: Temperature limits will be reduced to actual sensor specifications.

Contaminated Buffer

“CONTAMINATED BUFFER” appears in order to alert that the buffer could be contaminated. Refresh your buffer and continue the calibration procedure.

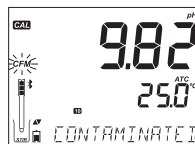

Broken Temperature Sensor

If the temperature sensor should malfunction or break at any time, a temperature of “25.0 °C” will blink on the second LCD line and the message “BROKEN TEMPERATURE SENSOR” will appear on the third LCD line after leaving calibration. The calibration will have the compensation at 25 °C. Replace probe if this occurs.

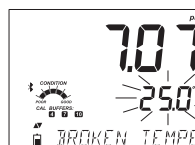

*Note: If this occurs during logging “25 °C !” will appear in the *.CSV file.*

pH GLP INFORMATION

Good Laboratory Practice (GLP) refers to a quality control function used to ensure uniformity of sensor calibrations and measurements. The dedicated **GLP/CFM** key opens a file of the latest calibration information. Use the **▼ ▲** keys to scroll the stored information. This includes the buffers used, temperature of the buffer, time and date of the last calibration, the sensor serial number and the calculated offset and percent slope. This information is available in Basic and Standard Modes. This information is also included with every data log. Newest calibration points report as a solid number, older calibration data (that is still used) will be displayed blinking.

If calibration has not been performed, the instrument displays a blinking “NO CAL” message.



After the calibration has been performed, the instrument displays offset and slope. The GLP slope is the average of the calibration slope; the percentage is referenced to the ideal slope value at 25 °C. Additionally, the condition and response indicators displayed are from the last calibration.



Pressing the \blacktriangledown \blacktriangle keys, the last calibration date (yyyy.mm.dd) together with the current reading is displayed.

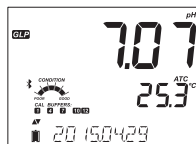

Note: If a custom buffer was used in calibration, the "C1" and "C2" tags will be displayed. If only the one buffer is used in calibration, the tag will be "C1" and the value will be displayed.

If disabled, "EXPIRATION WARNING DISABLED" is displayed.

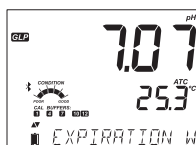

Or if enabled the number of days until the calibration alarm "CAL DUE" will be displayed. (i.e. "CAL EXPIRES IN 2 DAYS")

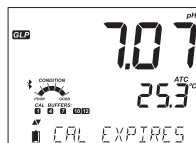

The number of days since the calibration expired. (i.e. "CAL EXPIRED 2 DAYS AGO").

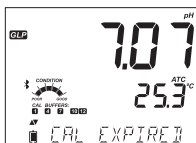

The abbreviated probe serial number together with the current reading. (See Setup for Full Serial Number).

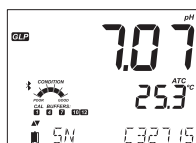

If a buffer is not from the last calibration, the buffer tag will be displayed blinking. If the calibration date and time are not in sync with the current date and time set on meter, the message "Inconsistent GLP time stamp" will be displayed.



In Standard Mode, Condition gauge is visible on the day of calibration (See Electrode Condition page 29). If configured in SETUP, a countdown message displays the number of days remaining until a new Calibration is due.

pH MEASUREMENT

When a HALO™ probe is connected, the instrument will recognize it and a cap removal message will be displayed. Press any key to skip the message. The instrument will enter measurement mode. Make sure the electrode has been calibrated before taking measurements.



Rinse the pH sensor with water and a sample if possible. Submerge the electrode tip approximately 3 cm (1¼") into the sample to be tested and stir sample gently. Allow time for the electrode to stabilize.

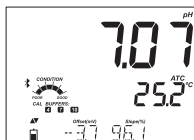

If measurements are taken successively in different samples, it is recommended to rinse the electrode thoroughly with deionized water or tap water and then with some of the next sample to prevent cross-contamination. The pH reading is affected by temperature. The temperature effect is compensated for using the temperature sensor inside the probe. The resulting measurement is the actual pH at the temperature of measurement.

The pH is displayed on the first LCD line and the temperature on the second LCD line. If the reading is out of measurement range, the closest full scale value will be displayed blinking on the first LCD line.

During measurement useful information can be displayed on the third LCD line by using the ▼▲ keys. Information is illustrated:

Offset and average slope (if the probe was calibrated)

Note: 100% slope will be displayed if a single point calibration was made.

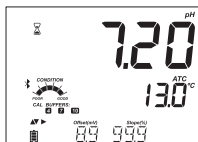

The current time



The current date



The status of meter battery



The status of probe battery

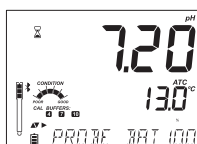

Note: If GLP/CFM key is pressed the HALO™ LED's on the connected probe will pulse 4-5 groups of fast flashes then return to normal operation. This may be useful to identify the operating probe from a group of probes.

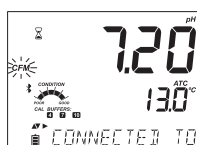

The code and the name of the currently connected probe. If the name was not changed (with Hanna Instruments LAB iPad app) it consists of the last six digits of the SN.

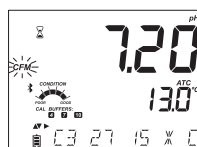

SCAN operation.

Press **GLP/CFM** key to identify other probes advertising in your vicinity. The current probe will remain connected until a new probe will be selected for connection. Bluetooth probes are detected by the auto-scan process and will appear.



DISCONNECT operation.

Press **GLP/CFM** key to disconnect probe from meter. The messages: "PROBE SET TO SHUTDOWN" or "PROBE SET TO STANDBY" will appear. The probe will not auto-connect if configured to shutdown. It will auto-connect if configured to standby to this probe in the current work session.

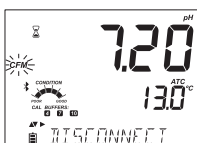

If probe disconnect mode in General Setup Menu is set to SHUTDOWN, the probe will turn off after several seconds, in order to save battery life. If the option in Setup is STANDBY, the probe will stay in continuous advertising, but in economy mode; it is visible only for the current meter and the LED will stop blinking. In order to connect to a different meter, press the button on the probe once.

Error Messages During Measurement

If the pH or temperature exceeds the limits of the sensor, the message "ELECTRODE OUT OF SPEC" will scroll on the third LCD line. The temperature will continue to be displayed. If temperature exceeds the meter specification of 120 °C, then "120 °C" will blink on the display. If interval logging is enabled, the message "OUT OF SPEC." will alternate with the LOG specific message. In both these cases and the Log file will indicate a "°C!" next to the data.

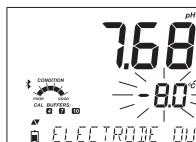

In case the temperature sensor is damaged, "BROKEN TEMPERATURE SENSOR" message will be displayed with "25.0 °C" blinking on the second LCD line. The Log file will indicate "°C!" next to the data.

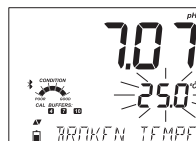

mV Reading Of The pH

The mV reading of the measured pH can be displayed on the LCD by pressing the **RANGE/▶** key.

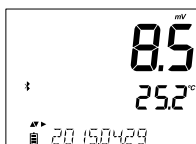

Temperature Setup for Manual Temperature Compensation

For sensors that are not equipped with a temperature sensor, a MTC temperature can be set in order to be used to compensate the pH value. In mV reading screen press **▶** to access the temperature edit screen. Use **▼** and **▲** keys to modify the temperature. Press **▶** to return to pH measurement screen.



Third Line Messages During Measurement

All the messages described in General Setup (page 14) are displayed in pH range.

Temperature Sensor Problem (if there is one)

Cal Due or Offset and Slope Value

Time

Date

Battery or Charge Status

Logging Messages

Out of Calibration Range



pH PROBE MAINTENANCE

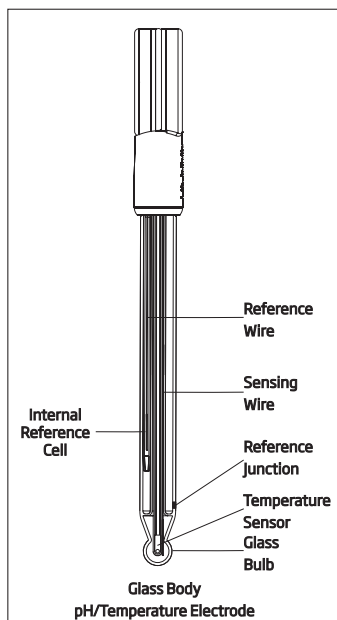

New Probe

pH probes are shipped with a cap that protects the bulb and junction from damage. When using a new probe, remove the protective bulb cap and inspect for damage.

Thoroughly rinse the probe with water to remove salt deposits that may have formed on the external surface of the probe during storage or shipping. The presence of salt deposits is normal. During transport, air bubbles may have formed inside the glass bulb. The temperature sensor is inside the pH bulb also and may restrict solution movement. Shake down the probe to ensure the internal buffer is in full contact with the inside of the pH bulb. Calibrate a new probe before measuring samples.

Measurement

Verify the HALO™ has been calibrated before taking measurements.

During measurement, always operate the probe with the pH sensing bulb facing down and the ceramic junction covered with solution. Use mechanical support (electrode arm) to steady the probe and allow hands free operation. Rinse the probe with deionized or distilled water between samples and dab dry with a lab wipe or disposable absorbent towel between samples. If measurements are made continually, periodically re-check calibration (if possible every 1-2 hours) to ensure the probe has remained calibrated. Be careful not to wet the black halo (electronics module) on the probe.

Storage

The glass sensing bulb on a pH probe should always be kept wet. If dry, remedy by soaking the pH bulb and reference junction in [HI70300](#) Storage Solution or if absent, pH 4.01 buffer. Soak for a minimum of one hour; an overnight soak is best. This will hydrate a dehydrated glass sensor and wet a dry reference junction.

Do not store the probe in ultrapure water. The pH glass surface can actually become dehydrated if stored or used in deionized or distilled water as ions are leached from sensing surface. pH electrodes require ions in a solution, preferably with a conductivity exceeding 200 mS/cm to function properly.

Cleaning Solutions

A sensor or reference that is coated or fouled in any way may produce drift or sluggish measurements. To ensure the best pH measurement possible, preventative maintenance and storage practices are strongly advised. A clean, conditioned Hanna Instruments pH electrode will provide the best measurement possible. Always use fresh buffers with each calibration; dirty electrodes can contaminate buffer solutions. Hanna Instruments manufactures a full line of cleaning solutions formulated to address general and specific cleaning needs.

For general cleaning, soak sensor tip in [HI7061](#) General cleaning solution for approximately 30 minutes. This will dissolve mineral deposits and other general coatings. After performing any cleaning procedure, rinse the electrode thoroughly with distilled/deionized water and soak the electrode in [HI70300](#) Storage solution for at least 1 hour before calibration or making measurements. There are other cleaning and disinfection reagents available from Hanna Instruments, formulated for specific contaminants.

Use diagnostic messages to aid pH electrode troubleshooting. Several cleaning solutions are available:

- General — Soak in Hanna Instruments [HI7061](#) or [HI8061](#) General Cleaning Solution for approximately ½ hour.
- Protein — Soak in Hanna Instruments [HI7073](#) or [HI8073](#) Protein Cleaning Solution for 15 minutes.
- Inorganic — Soak in Hanna Instruments [HI7074](#) Inorganic Cleaning Solution for 15 minutes.
- Oil/grease — Rinse with Hanna Instruments [HI7077](#) or [HI8077](#) Oil and Fat Cleaning Solution.

Note: After performing any of the cleaning procedures, rinse the electrode thoroughly with distilled water, refill the reference chamber with fresh electrolyte (not necessary for gel-filled electrodes) and soak the electrode in [HI70300](#) or [HI80300](#) Storage Solution for at least 1 hour before taking measurements.

PH PROBE BATTERY REPLACEMENT

1. If required, disconnect probe from meter by pressing the indented button located on the top of the probe until indicator halo stops flashing.
2. Unscrew the battery compartment cover and set aside. The old battery is removed by inserting a straight edge (such as a screwdriver) into the recessed notch and prying it up.
3. Replace battery with a new CR2032 3V lithium battery (+ faces outward).
4. Replace battery compartment cover.

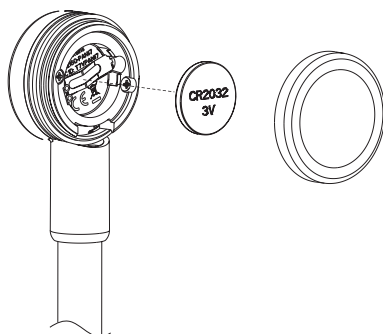

TROUBLESHOOTING GUIDE

Symptoms	Problems	Solution
NO PROBE	Probe model not recognized.	A) Make sure the probe's battery is not depleted and probe is advertising. The LED will show the state of connection. B) Press GLP/CFM key while scan operation. C) Move meter closer to probe and try to connect again.
Slow response/excessive drift.	Dirty pH electrode.	Clean the electrode by placing the tip in HI7061 or HI8061 for 30 minutes, rinse and then soak in HI70300 Storage Solution.
Readings fluctuate up and down (noise).	pH: Clogged/dirty junction. Low electrolyte level (refillable electrodes only).	A) Shake probe down. B) Clean the electrode. Refill with fresh solution (for refillable electrodes only).
Buffer/standard solution for calibration is not accepted.	pH: Dirty electrode or contaminated buffer.	A) Verify protective cap has been removed. B) Replace buffer with fresh buffers. C) Follow the cleaning procedure. If still no results, replace the probe.
PROBE OUT OF SPEC.	Out of range in the mV scale/or pH.	A) Verify the protective cap has been removed. B) Verify pH bulb and ceramic are in the buffer or sample. C) Verify no bubbles inside pH membrane.
The meter does not measure temperature. "25°C" is displayed on second LCD line.	Broken temperature sensor.	Replace the probe.
The probe fails to calibrate or gives faulty readings.	Broken pH electrode.	Replace the probe.
At startup the meter displays all LCD tags permanently.	The ON/OFF button is stucked.	Contact your local Hanna Instruments Office.
CAL tag with "FACT DUE" message at startup.	Instrument was not factory calibrated or lost factory calibration.	Contact your local Hanna Instruments Office.
CONNECTION ERROR	Probe not connected	A) Try pressing operation button on Probe. Scan and confirm (GLP/CFM key). B) Check if another edge[®] blu or iPad is connected to the probe. C) Try bringing the Probe closer to the meter.
INCOMPATIBLE PROBE PROBE NOT CONFIGURED BAD PROBE	Update needed or a probe hardware issue.	Contact your local Hanna Instruments Office.

	pH, mV in pH	Temperature
Range	-2.00 to 16.00 pH -2.000 to 16.000 pH* ±1000.0 mV in pH	-20.0 to 120.0 °C ; -4.0 to 248.0 °F**
Resolution	0.01 pH 0.001 pH* 0.1 mV	0.1 °C; 0.1 °F
Accuracy @ 25 °C/77 °F	±0.01 pH ±0.002 pH* ±0.2 mV	±0.5 °C; ±0.9 °F
pH Calibration	Basic mode: Automatic, up to 3 points calibration 5 standard buffer Standard mode: Automatic up to 5 points calibration 7 standard buffers (pH 1.68*, 4.01 or 3.00, 6.86, 7.01, 9.18, 10.01, 12.45*) and 2 custom buffers*	
Temperature compensation	Automatic -5 to 100 °C (23 to 212 °F) (using integral temperature sensor) Manual (if no temperature sensor featured on electrode)	
Log feature	Up to 1000* records organized in: Log on demand (Max. 200 logs) Log on stability (Max. 200 logs) Interval logging*	

*Standard Mode Only

** pH and temperature will be reduced to actual probe/sensor limits.

Additional Specifications	
PC Interface	Micro USB
Storage Interface	USB
Power Supply	5 VDC Adapter (included)
Environment	0-50 °C (32-122 °F) Max 95% RH non-condensing
Dimensions	202 x 140 x 12 mm (7.9 x 5.5 x 0.5")
Weight	250g (8.82 oz)
pH Electrode	HI11102 Glass body, gel filled combination pH probe with Bluetooth [®] Smart technology (included)

HI11102 SPECIFICATIONS

Specifications	
Reference	Double, Ag/AgCl
Junction	Ceramic
Electrolyte	Gel
Range	0.00 to 12.00 pH ±420 mV -5.0 to 80.0 °C (23.0 to 176.0 °F)
Bulb Shape	Spherical
Outer Diameter (glass)	12 mm (glass)
Overall Length	183 mm
Solution Temperature	-5.0 to 80.0 °C (23.0 to 176.0 °F)
Environment	0.0 to 50.0 °C (32.0 to 122.0 °F) electronic module is not waterproof
Temperature Sensor	Integrated
Body Material	Glass
Connection	Bluetooth® Smart (Bluetooth® 4.0), 10 m (33') range
Battery Type/ Life	CR2032 3V lithium ion / approximately 500 hours

ELECTRODES/PROBES

HI11102	Glass body, gel filled HALO™ pH probe with Bluetooth® Smart technology
HI11312	Glass body, refillable HALO™ pH probe with Bluetooth® Smart technology
HI12302	Plastic body, gel filled HALO™ pH probe with Bluetooth® Smart technology
FC2022	PVDF body, HALO™ pH probe with Bluetooth® Smart technology
HI10482	Glass body, refillable HALO™ pH probe with Bluetooth® Smart technology
HI12922	Glass body, refillable HALO™ pH probe with Bluetooth® Smart technology
FC2142	Titanium body, gel filled HALO™ pH probe with Bluetooth® Smart technology
HI14142	Glass body, viscolene filled HALO™ pH probe with Bluetooth® Smart technology
HI13302	Glass body, viscolene filled HALO™ pH probe with Bluetooth® Smart technology
HI10832	Glass body, viscolene filled HALO™ pH probe with Bluetooth® Smart technology

BUFFER SOLUTIONS

HI70004P	pH 4.01 Buffer Sachets, 20 mL (25 pcs.)
HI70007P	pH 7.01 Buffer Sachets, 20 mL (25 pcs.)
HI70010P	pH 10.01 Buffer Sachets, 20 mL (25 pcs.)
HI7001L	pH 1.68 Buffer Solution, 500 mL
HI7004L	pH 4.01 Buffer Solution, 500 mL
HI7006L	pH 6.86 Buffer Solution, 500 mL
HI7007L	pH 7.01 Buffer Solution, 500 mL
HI7009L	pH 9.18 Buffer Solution, 500 mL
HI7010L	pH 10.01 Buffer Solution, 500 mL
HI8004L	pH 4.01 Buffer Solution in FDA approved bottle, 500 mL
HI8006L	pH 6.86 Buffer Solution in FDA approved bottle, 500 mL
HI8007L	pH 7.01 Buffer Solution in FDA approved bottle, 500 mL
HI8009L	pH 9.18 Buffer Solution in FDA approved bottle, 500 mL
HI8010L	pH 10.01 Buffer Solution in FDA approved bottle, 500 mL

ELECTRODE STORAGE SOLUTIONS

HI70300L	Storage Solution, 500 mL
HI80300L	Storage Solution in FDA approved bottle, 500 mL

ELECTRODE CLEANING SOLUTIONS

HI70000P	Electrode Rinse Sachets, 20 mL (25 pcs.)
HI7061L	General Cleaning Solution, 500 mL

HI7073L	Protein Cleaning Solution, 500 mL
HI7074L	Inorganic Cleaning Solution, 500 mL
HI7077L	Oil & Fat Cleaning Solution, 500 mL
HI8061L	General Cleaning Solution in FDA approved bottle, 500 mL
HI8073L	Protein Cleaning Solution in FDA approved bottle, 500 mL
HI8077L	Oil & Fat Cleaning Solution in FDA approved bottle, 500 mL

ELECTRODE FILL SOLUTIONS

HI7082	3.5M KCl Electrolyte, 4x30 mL, for double junction electrodes
HI8082	3.5M KCl Electrolyte in FDA approved bottle, 4x30 mL, for double junction electrodes.

OTHER ACCESSORIES

HI75110/220U	Voltage adapter from 115 Vac to 5 Vdc (USA plug)
HI75110/220E	Voltage adapter from 230 Vac to 5 Vdc (European plug)
HI76404W	Electrode holder
HI2000WCW	Wall cradle
HI2000BCW	Bench cradle
HI920015	Micro USB cable

Warranty

The edge® blu is warranted for two years against defects in workmanship and materials when used for its intended purpose and maintained according to instructions. Electrodes and probes are warranted for six months. This warranty is limited to repair or replacement free of charge.

Damage due to accidents, misuse, tampering or lack of prescribed maintenance is not covered. If service is required, contact your local Hanna Instruments Office.

If under warranty, report the model number, date of purchase, serial number and the nature of the problem. If the repair is not covered by the warranty, you will be notified of the charges incurred. If the instrument is to be returned to Hanna Instruments, first obtain a Returned Goods Authorization number from the Technical Service department and then send it with shipping costs prepaid. When shipping any instrument, make sure it is properly packed for complete protection.

World Headquarters

Hanna Instruments Inc.
Highland Industrial Park
584 Park East Drive
Woonsocket, RI 02895 USA
www.hannainst.com

Local Office

Hanna Instruments USA
270 George Washington Highway
Smithfield, RI 02917
Phone: 800.426.6287
Fax: 401.765.7575
e-mail: tech@hannainst.com



MANEDGEBLU

Printed in ROMANIA